

COMPACT Diode Laser System 300/300 (300W, 300µm)

Features

Easy-to-integrate system consists of a compact 19" (11HU including water-air-chiller), rack-mountable chassis, metal-armored fiber and imaging optics with protection glass. Can be combined with DILAS' processing heads offering camera and pyrometer options, and allowing the closed-loop operation of the system in pre-defined temperature ranges for quality relevant applications in medical device manufacturing and automotive.

Available with an optional fiber-input galvo scanner featuring a field of operation in which the laser spot can be freely addressed.



Device Specification

Optical	Units	
Optical Output Power	W	300
Stability Over 24-hour (Cooling-Water $\Delta T = \pm 1K$)	%	± 2
Wavelength ¹	nm	808/980 ¹
Wavelength Tolerance ¹	nm	$\pm 10^1$

Pilot Laser		
Wavelength	nm	650
Output Power	mW	<1

Fiber Parameters		
Fiber Connector Type		QBH (Water-Cooled)
Fiber Length ¹	m	5
Numerical Aperture	NA	0.2
Fiber Core Diameter	µm	300

Electrical Parameters		
Operating Voltage	V	200-240 Single Phase
Frequency	Hz	50/60
Power Consumption	kVA	1.4
Overall Efficiency	%	>12
Max. Rep Rate	Hz	500
Min. Pulse Width	µs	200
Min. Rise/Fall-Time	µs	150

Thermal Parameters		
Temperature Ambient in Operation (100% duty cycle)	°C	15 to 40 (Non-Condensing)
Storage Temperature	°C	5 to 50

Mechanical		
Dimension (Including Water/Air-Chiller) [w x h x d]	mm ³	483 x 487 x 630
Weight (Including Water/Air-Chiller)	kg	65
Noise Emission	dB(A)	<70

Package Includes

¹COMPACT Laser Unit: 5m length¹, water-air chiller, 2 warning lights and focusing unit PHF00 (f= 100mm). Consult the COMPACT Series Operating Instruction Manual for additional information.

¹Consult DILAS Industrial Laser Systems for other available options.

Package Dimension

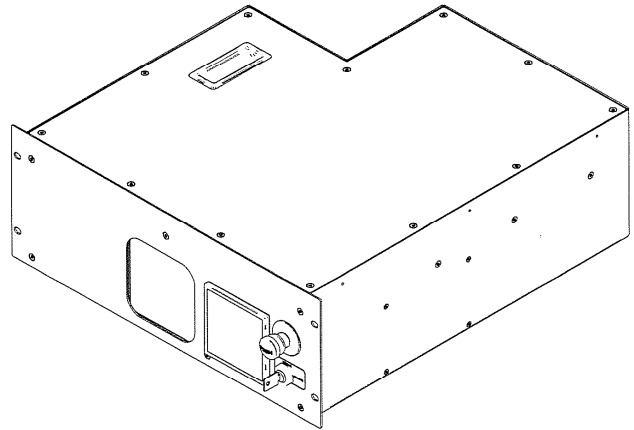
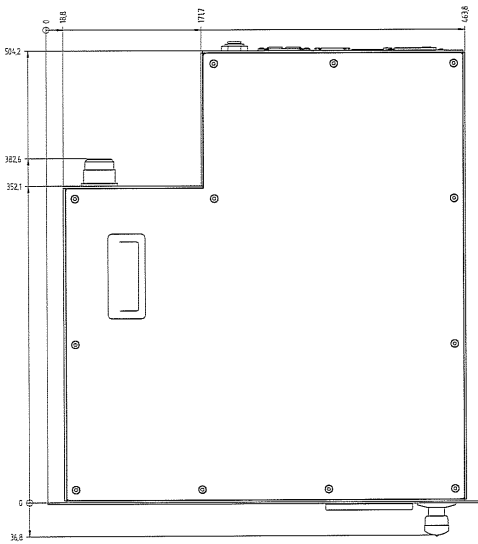
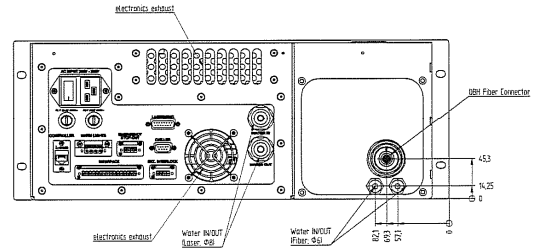
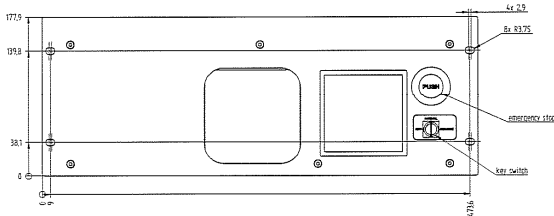

U.S. CFR Regulation

The manufacturer and subsequent sale of laser equipment is under the guidelines governed by the U.S. Center for Devices and Radiological Health (CDRH). In accordance to those guidelines, specifically Subchapter J of the Radiation Standards, 21 CFR, the diode laser is registered as a CLASS 4 laser product.

European Commission

In accordance to EN 60825, Safety of Laser Products, the diode laser is registered as a CLASS 4 laser product.

Products specifications are subject to change without notice. For handling precautions, please reference the general handling instruction manual. For additional information, please contact your local sales representative or visit our website at www.dilas-ils.com.

DILAS Industrial Laser Systems
 a division of DILAS Diodenlaser GmbH
 Galileo-Galilei-Straße 10
 55129 Mainz
 Germany

Phone: +49 (6131) 9226 400
 Fax: +49 (6131) 9226 444
 Email: sales@dilas-ils.com
www.DILAS-ILS.com

Water-Air Chiller RK/W 800L

Features

- High cooling capacity
- Small size cabinet
- Easy to integrate into standard industrial mounting racks
- Easy serviceable spare parts access



Device Specification

Electrical Parameters

		Units	
Operating Voltage		V	200-240 Single Phase
Frequency		Hz	50/60
Current Consumption	in Operation	A	3.9
	max.	A	6
Fuse	max.	A	10
Cooling Capacity		W	800
Heat Exchanger			V2A

Pump (NPY 50/60Hz)

Number of Pumps			1
Pump Capacity	Q_{max}	l/min	12
Pump Height	H_{max}	m	50
Rated Current for Pump		A	1.3

Other

Water Tank Volume		l	8
Connectors for Supply/Return Line		"	3/8
Heating			./.
Temperature Controller			./.

Mechanical

Dimensions		mm	483 x 311 x 630
Weight	Empty	kg	~ 33
	with Water	kg	~ 41
Noise Emission		dB (A)	<57

(A-weighted equivalent continuous sound level)

Water-Air Chiller RK/W 800L¹

¹Only use Water-Air Chiller RK/W 800L with the COMPACT (Liquid-Cooled) Series

Package Dimension

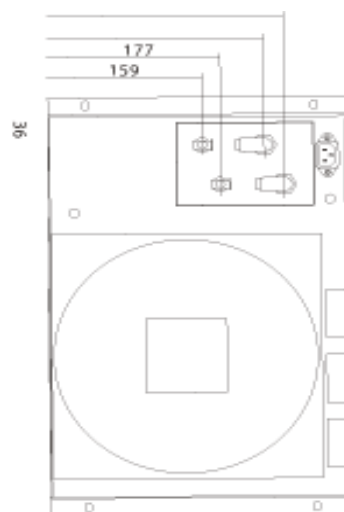
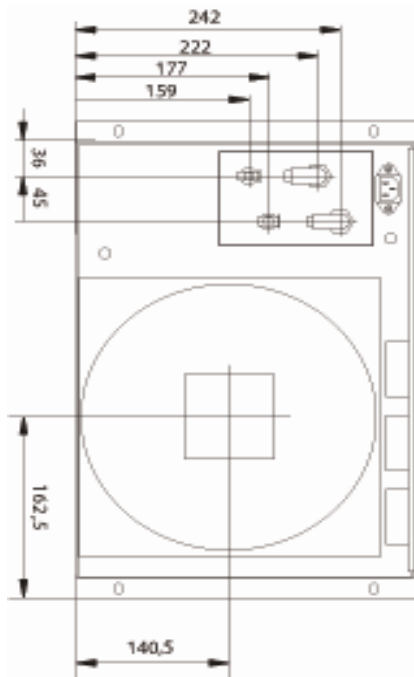
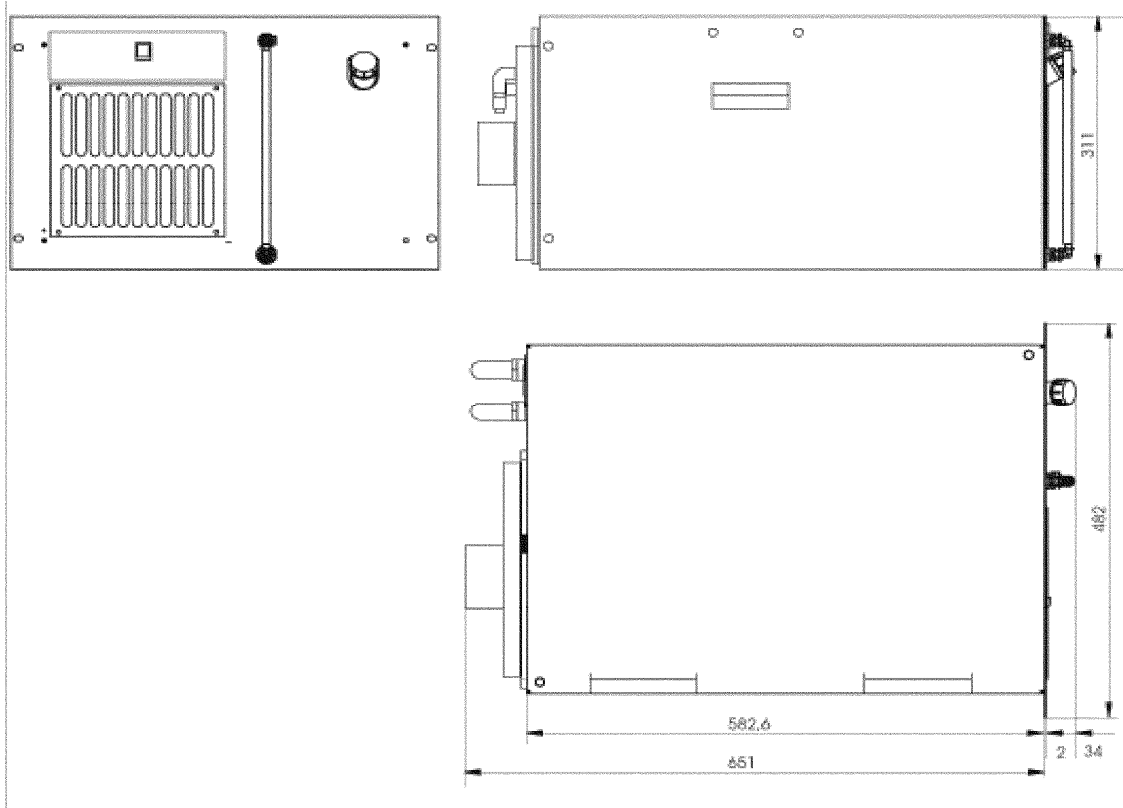

U.S. CFR Regulation

The manufacturer and subsequent sale of laser equipment is under the guidelines governed by the U.S. Center for Devices and Radiological Health (CDRH). In accordance to those guidelines, specifically Subchapter J of the Radiation Standards, 21 CFR, the diode laser is registered as a CLASS 4 laser product.

European Commission

In accordance to EN 60825, Safety of Laser Products, the diode laser is registered as a CLASS 4 laser product.

Products specifications are subject to change without notice. For handling precautions, please reference the general handling instruction manual. For additional information, please contact your local sales representative or visit our website at www.dilas-ils.com.

DILAS Industrial Laser Systems

a division of DILAS Diodenlaser GmbH
Galileo-Galilei-Straße 10
55129 Mainz
Germany

Phone: +49 (6131) 9226 400
Fax: +49 (6131) 9226 444
Email: sales@dilas-ils.com
www.DILAS-ILS.com

Processing Head (PHFO) COMPACT Series Diode Laser System

Features

This processing head with $f=100\text{mm}$ (standard focal length)¹ is intended to be used with Compact Series along with an RQB or QBH fiber coupling. The processing head is connected to the diode laser using a fiber connector with RQB/QBH.

Having a compact housing this processing head can easily be integrated into the laser process.

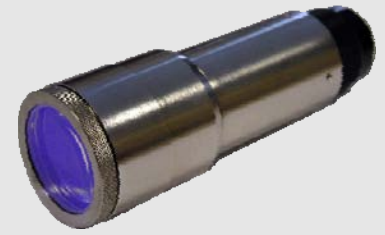

Optical		Standard		Optional	
Connector		RQB or QBH	RQB or QBH	RQB or QBH	RQB or QBH
Numerical Aperture	NA	0.22	0.22	0.22	0.22
Focal Length	mm	100	60	50 ²	38 ²
Working Distance (Stand Off)	mm	95	54	38	25
Output Aperture	mm	40	40	40	40

Weight					
Weight	kg	0.66	0.66	0.66	0.66

Fiber	μm	400	400	400	400
Focal Size ⁷	mm	0.6 \pm 0.05	0.4 \pm 0.05	0.3 \pm 0.05	0.25 \pm 0.05

¹Focal dimensions of diode lasers can deviate in practice depending on measuring method by $\pm 10\%$.

²With additional meniscus lens adapter.

³For standard focal length $f=100$.

Package Dimensions ³		
Length	mm	144.2
Diameter	\varnothing	48

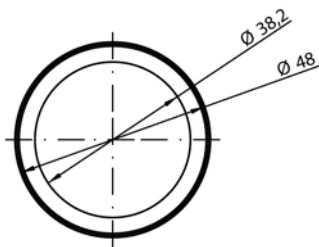

Spot size, see table above

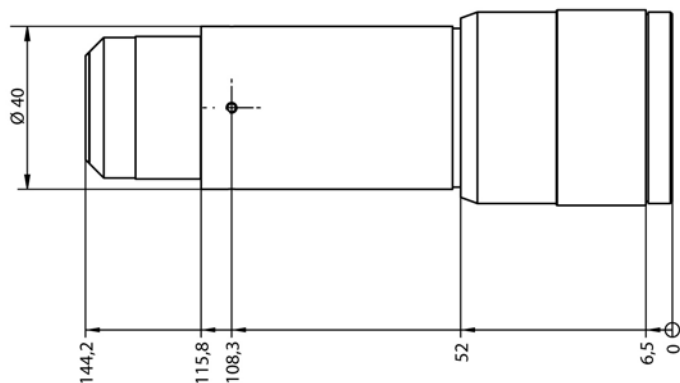

U.S. CFR Regulation

The manufacturer and subsequent sale of laser equipment is under the guidelines governed by the U.S. Center for Devices and Radiological Health (CDRH). In accordance to those guidelines, specifically Subchapter J of the Radiation Standards, 21 CFR, the diode laser is registered as a CLASS 4 laser product.

European Commission

In accordance to EN 60825, Safety of Laser Products, the diode laser is registered as a CLASS 4 laser product.

Products specifications are subject to change without notice. For handling precautions, please reference the general handling instruction manual. For additional information, please contact your local sales representative or visit our website at www.dilas-ils.com.

DILAS Industrial Laser Systems

a division of DILAS Diodenlaser GmbH
Galileo-Galilei-Straße 10
55129 Mainz
Germany

Phone: +49 (6131) 9226 400
Fax: +49 (6131) 9226 444
Email: sales@dilas-ils.com
www.DILAS-ILS.com